

Inline Detonation Flame Arrester

EC design test certificate no.

Standard gap (MESG)

Explosion group

Operating direction

Flange connection

Thread connection

Weight

: 1002-0026-70

: IBExU 21 ATEX 2110 X

: < 0,50 mm

: G IIC

: Bidirektional / Bi-directional

: EN1092-1 (DIN2576) Typ01 PN10/16

: n.a.

: ~ 28,1 kg

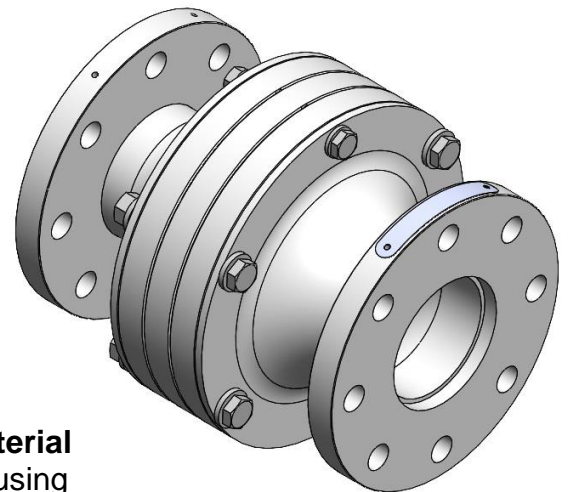
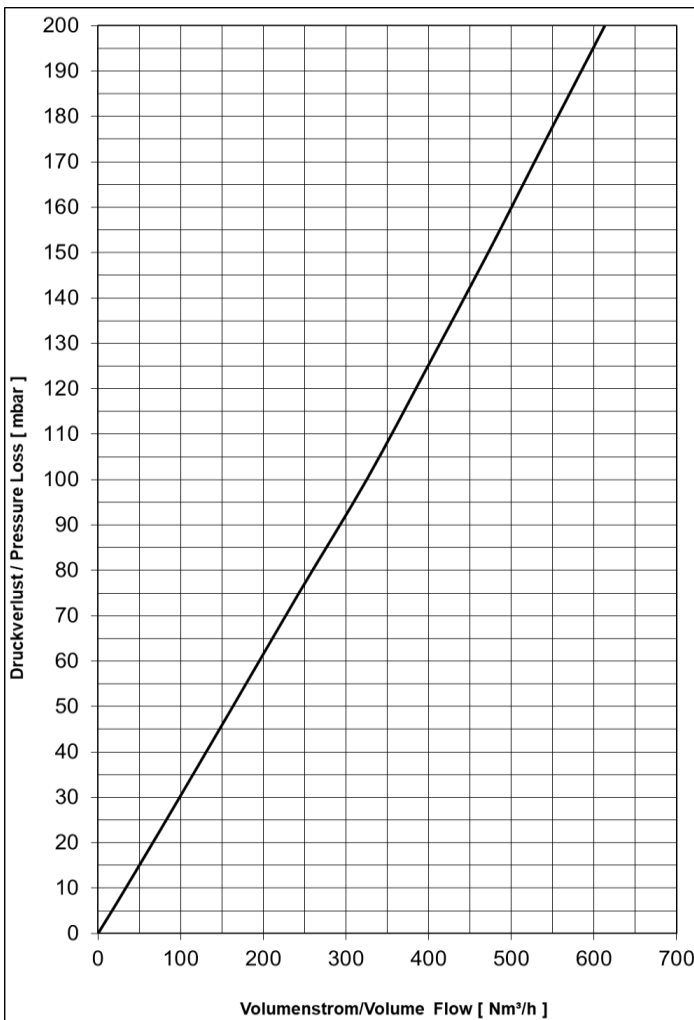

Material

Housing

V4A/AISI 316 range

Flame Arrester Element

V4A/AISI 316 range

O-Ring

PTFE

Operating Data

Type : DET 4

Absolute pressure : ≤ 1,2 bar

Temperature : ≤ 60,0 °C

Nominal pipe size : ≤ DN80

Pressure loss

Medium Air

po = 1013 mbar, To = 273K, density = 1,293 kg/m³